

# Alphabet Tracing Worksheets

from Letter A to Letter Z

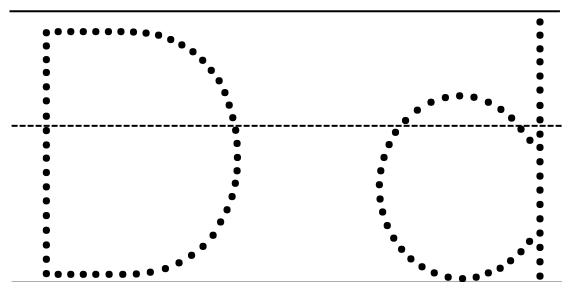
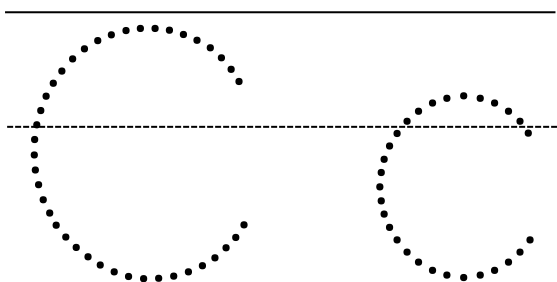
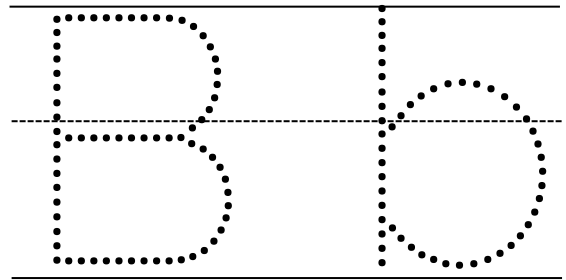
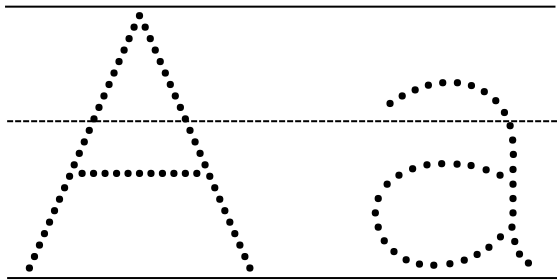
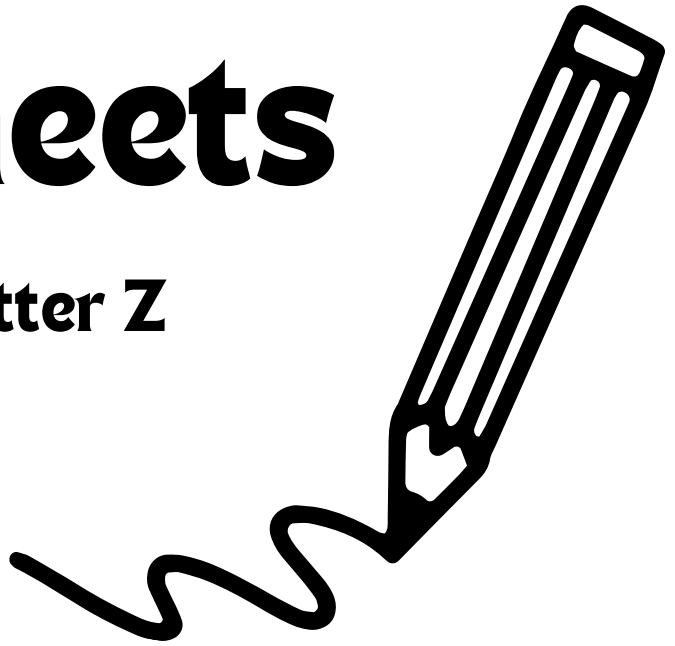

Name: \_\_\_\_\_

# Letter Sounds

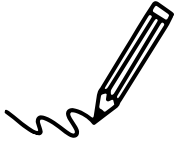

Directions: Color the picture, then trace the letter.

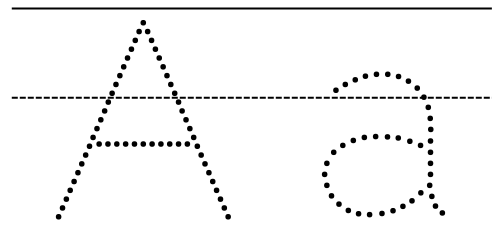
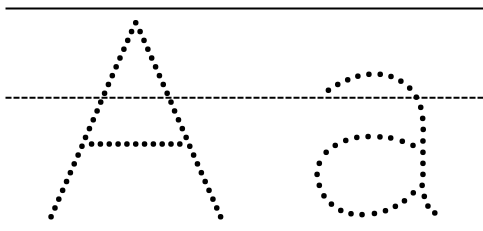
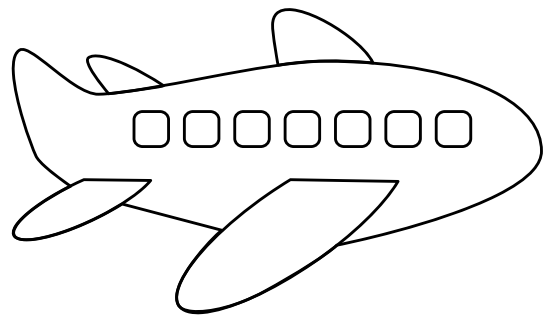
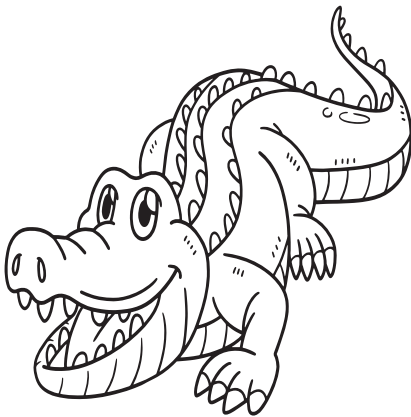
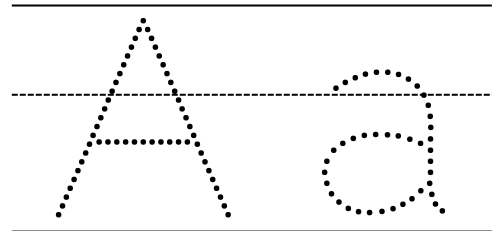
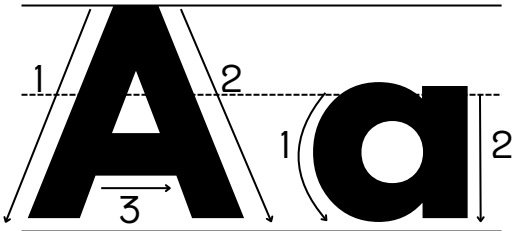
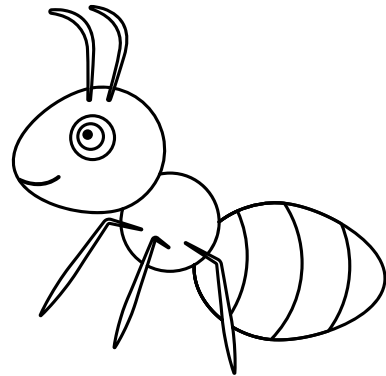
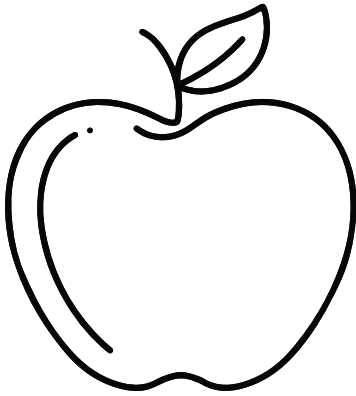
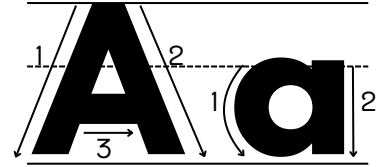

Name: \_\_\_\_\_

# Letter Sounds

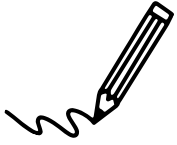

Directions: Color the picture, then trace the letter.

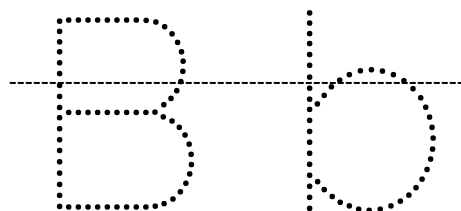
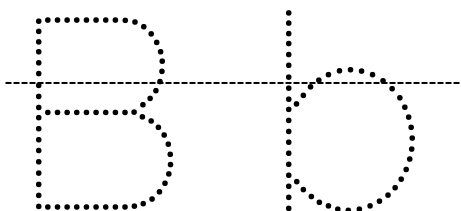
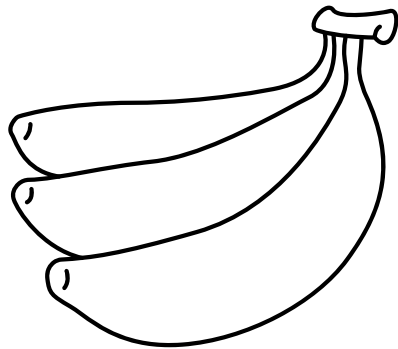
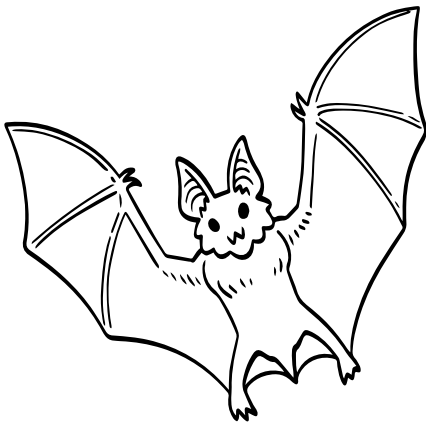
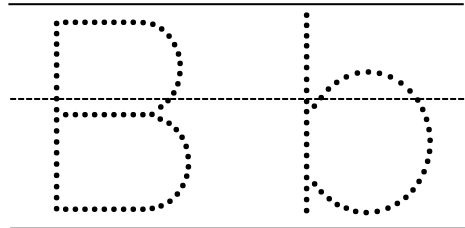
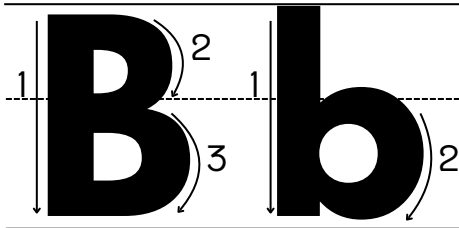
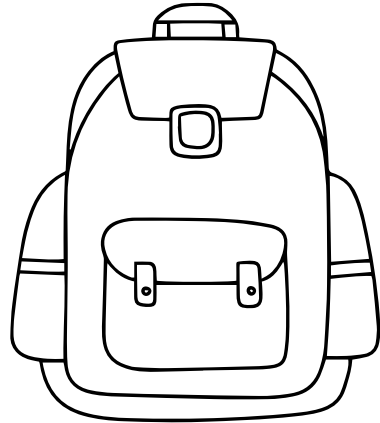
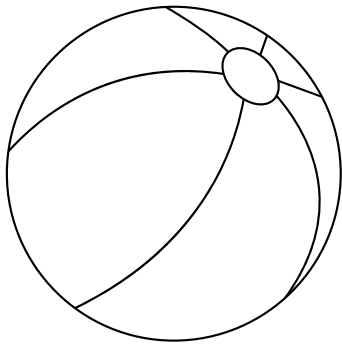
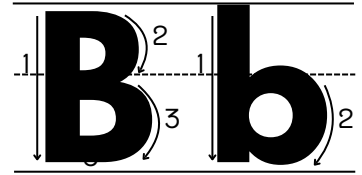

Name: \_\_\_\_\_

# Letter Sounds



Directions: Color the picture,  
then trace the letter.

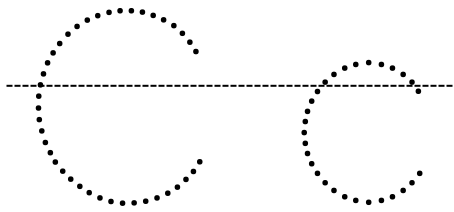
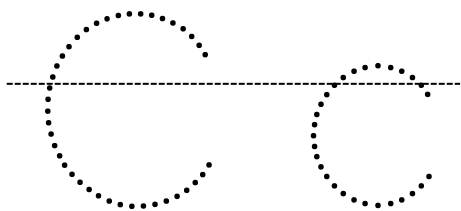
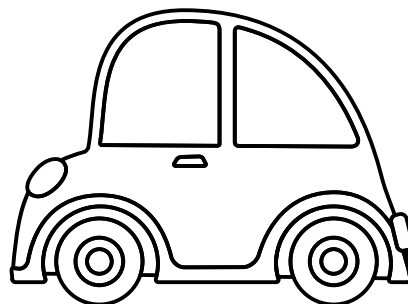
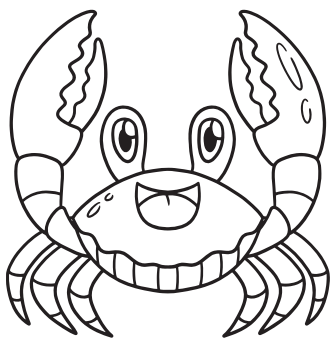
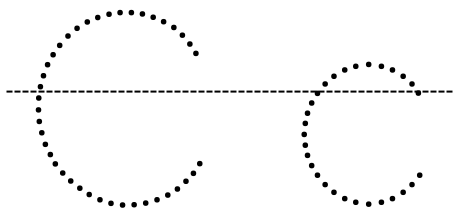
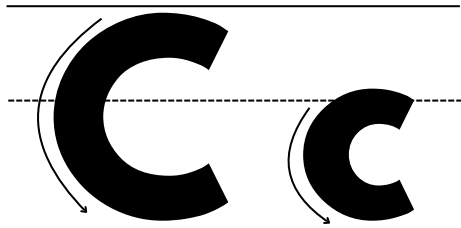
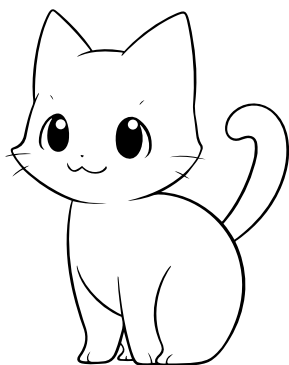
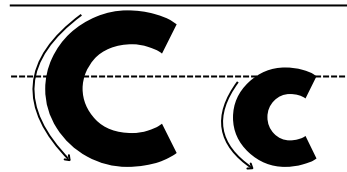

Name: \_\_\_\_\_

# Letter Sounds

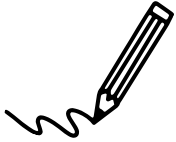

Directions: Color the picture, then trace the letter.

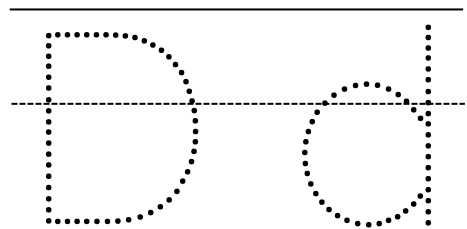
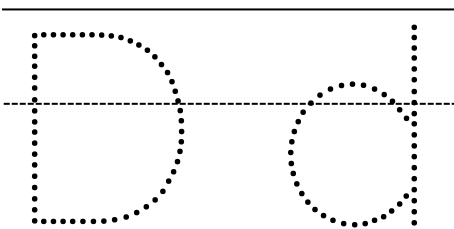
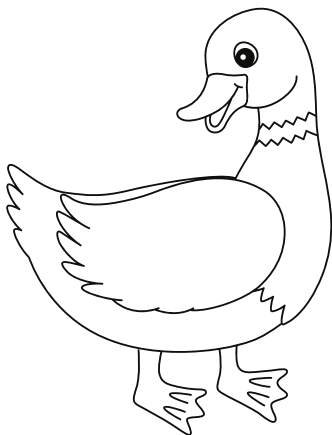
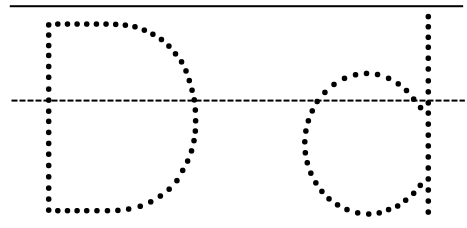
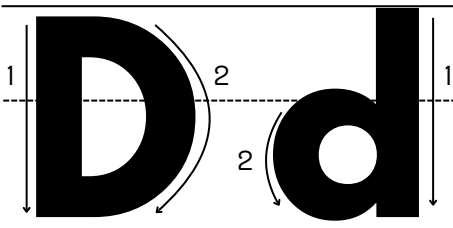
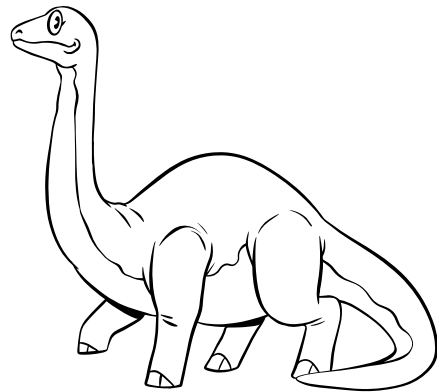
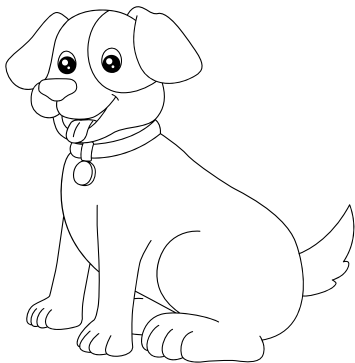
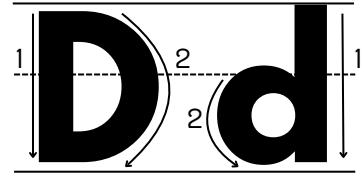

Name: \_\_\_\_\_

# Letter Sounds

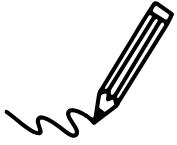

Directions: Color the picture, then trace the letter.

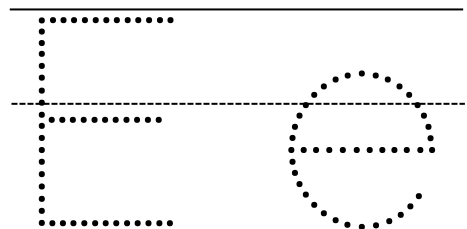
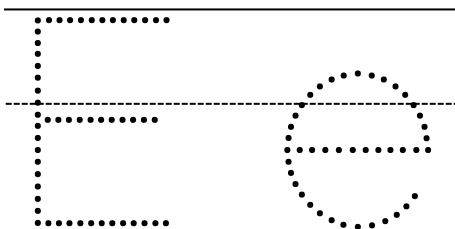
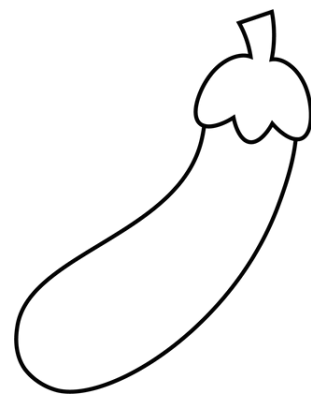
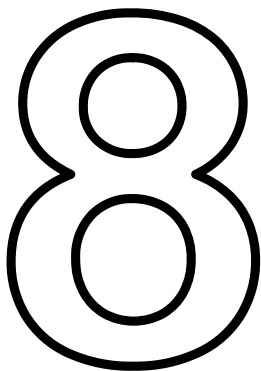
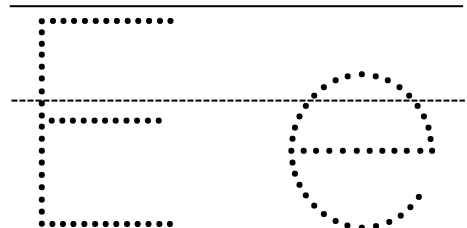
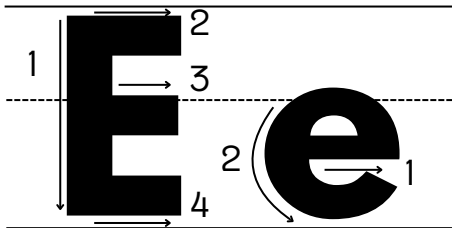
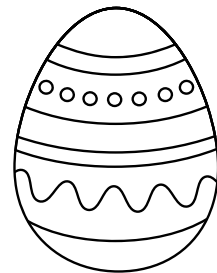
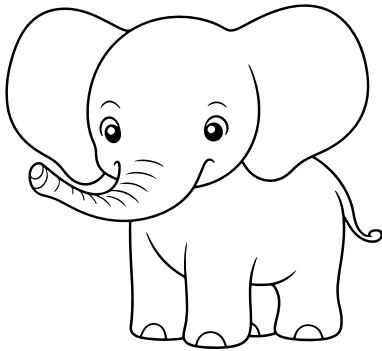
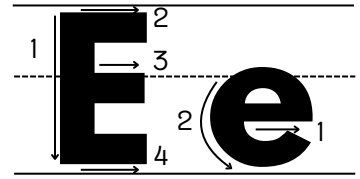

Name: \_\_\_\_\_

# Letter Sounds



Directions: Color the picture, then trace the letter.

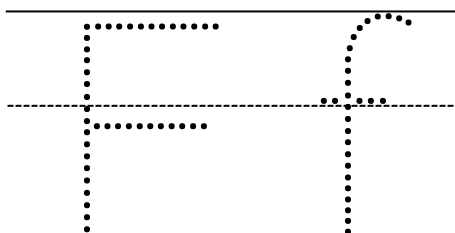
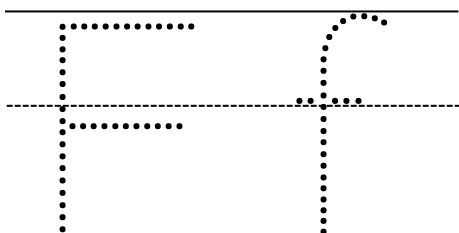
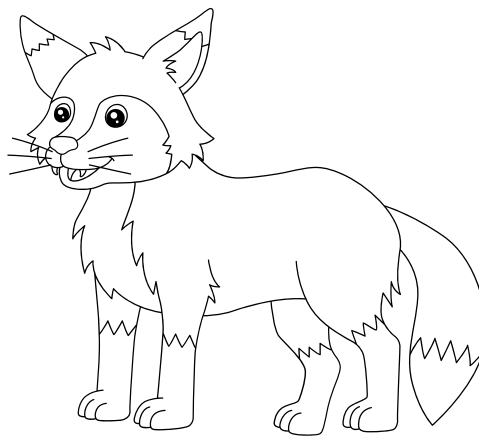
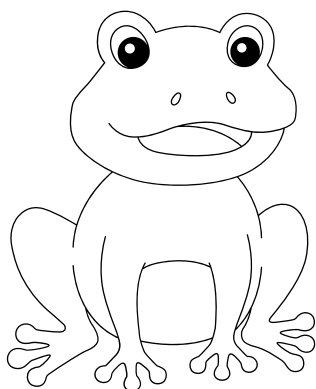
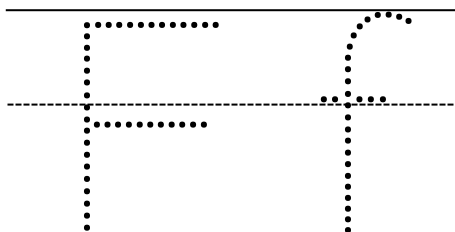
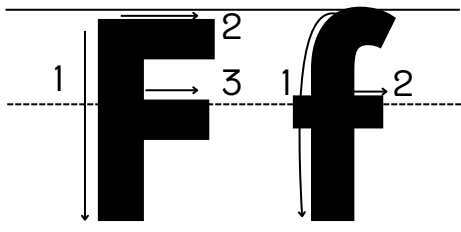
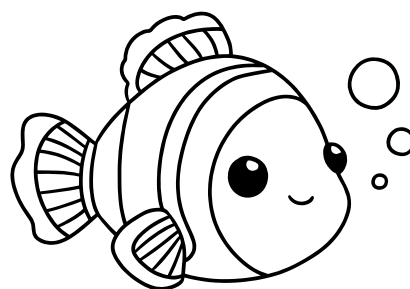
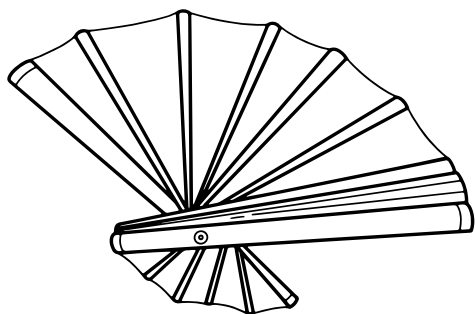
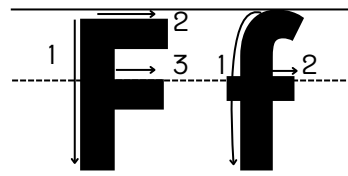

Name: \_\_\_\_\_

# Letter Sounds



Directions: Color the picture, then trace the letter.

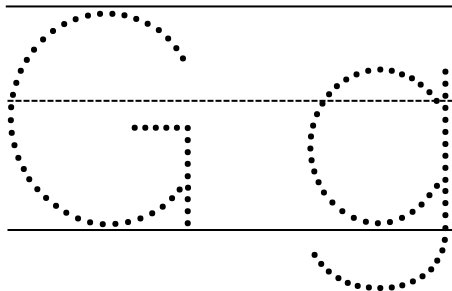
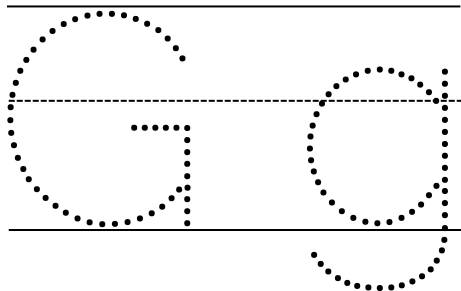
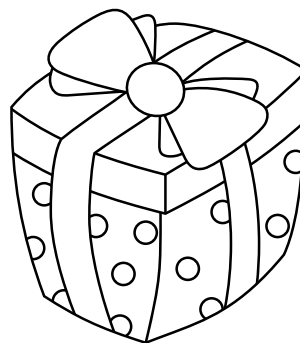
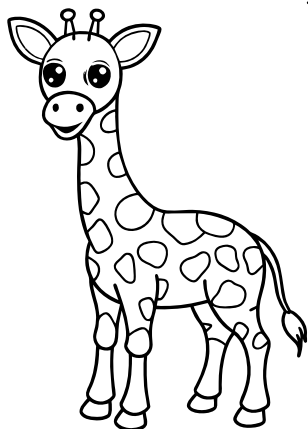
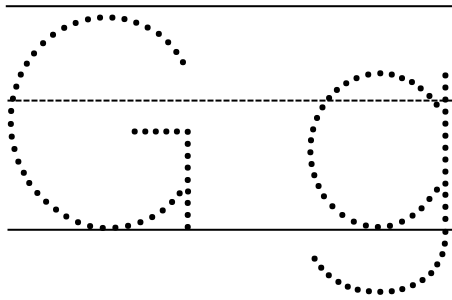
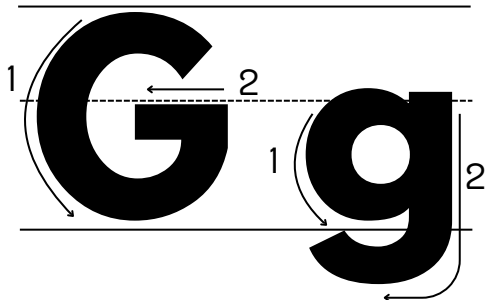
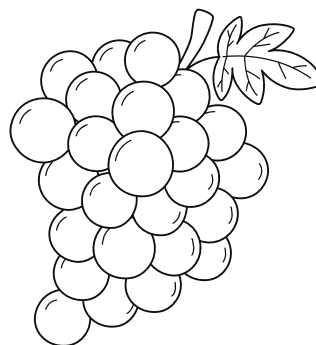
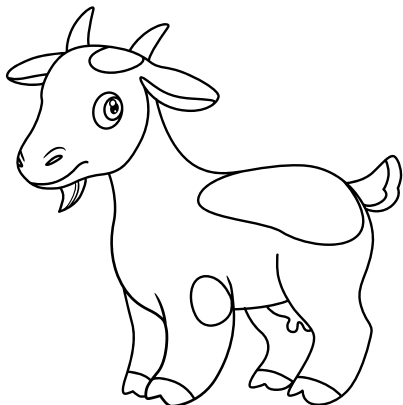
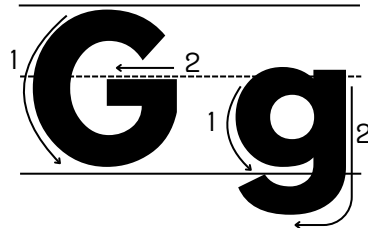



Name: \_\_\_\_\_

# Letter Sounds



Directions: Color the picture, then trace the letter.

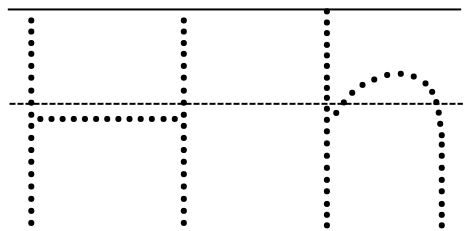
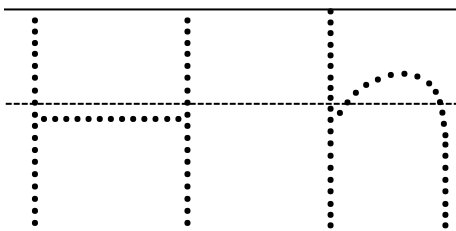
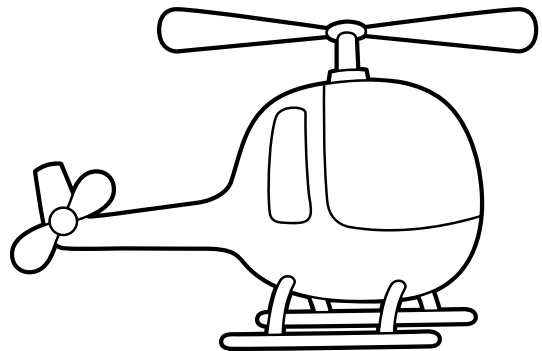
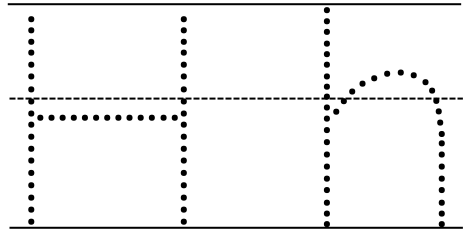
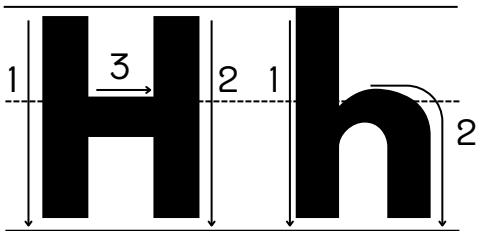
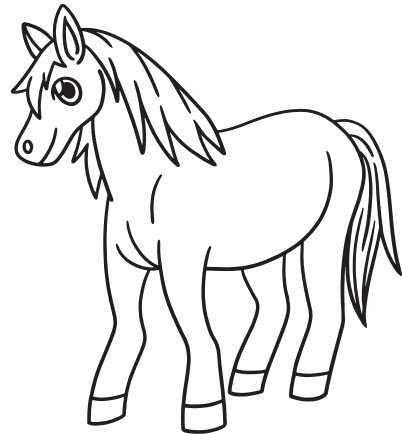
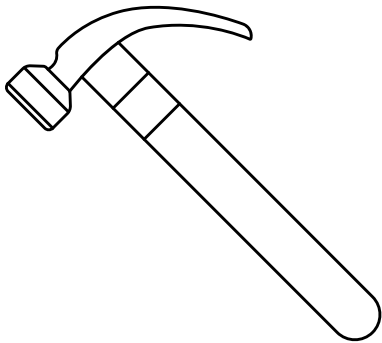
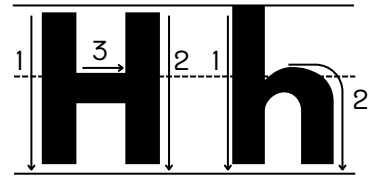

Name: \_\_\_\_\_

# Letter Sounds

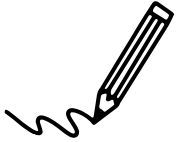

Directions: Color the picture, then trace the letter.

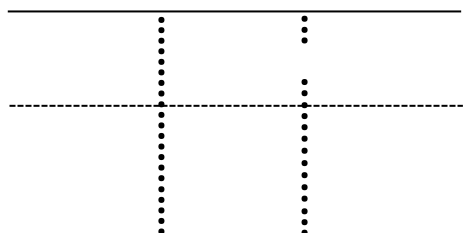
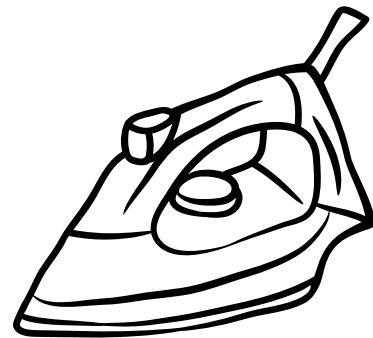
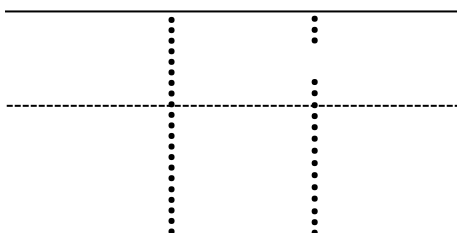
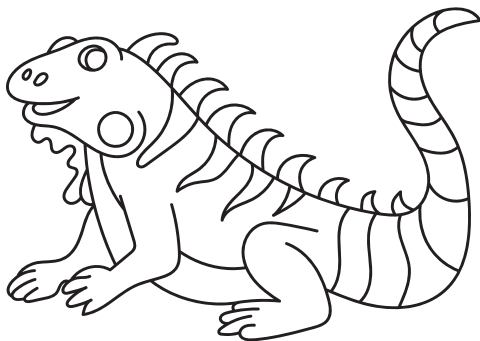
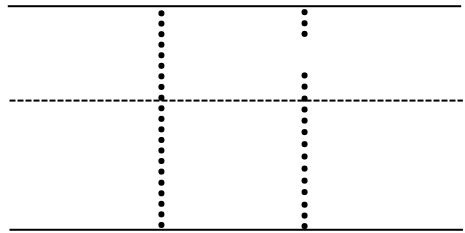
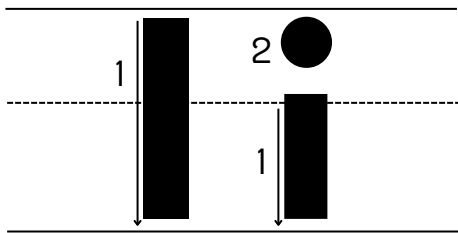
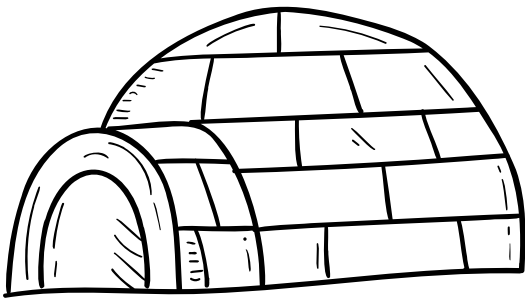
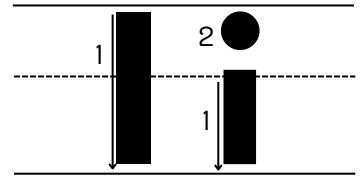

Name: \_\_\_\_\_

# Letter Sounds

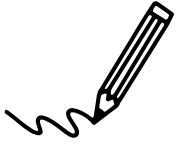

Directions: Color the picture,  
then trace the letter.

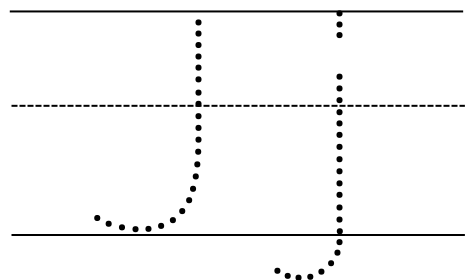
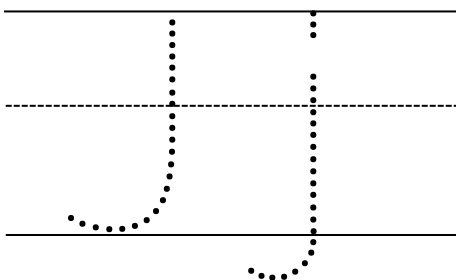
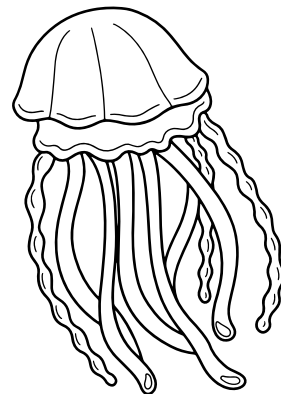
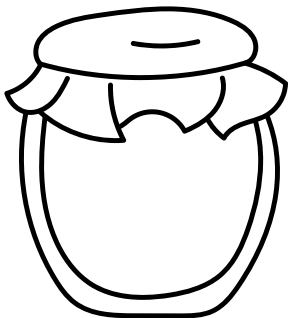
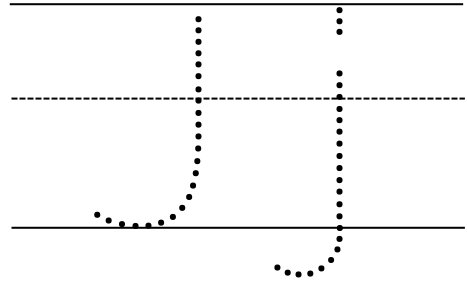
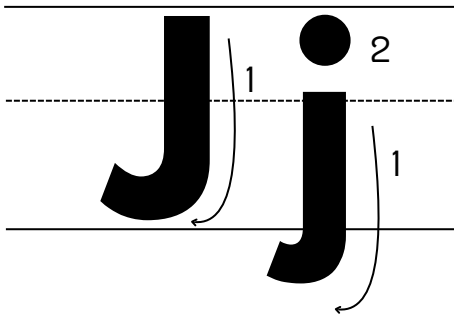
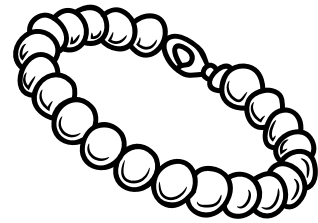
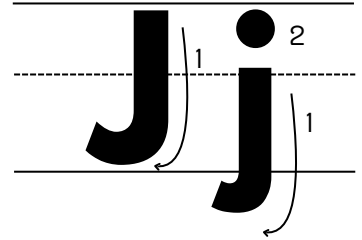

Name: \_\_\_\_\_

# Letter Sounds

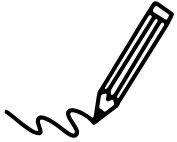

Directions: Color the picture, then trace the letter.

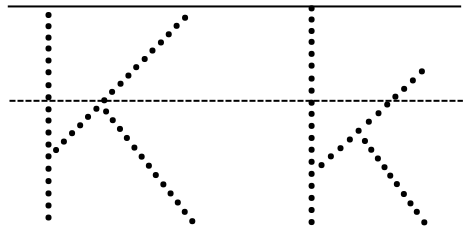
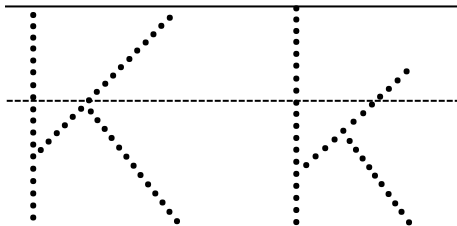
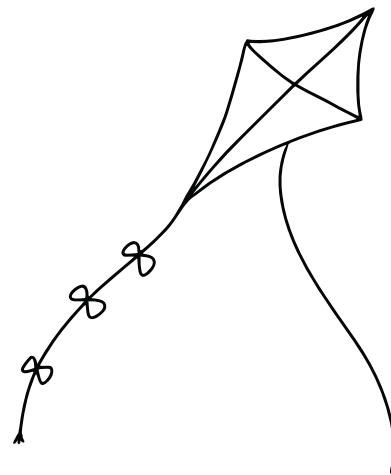
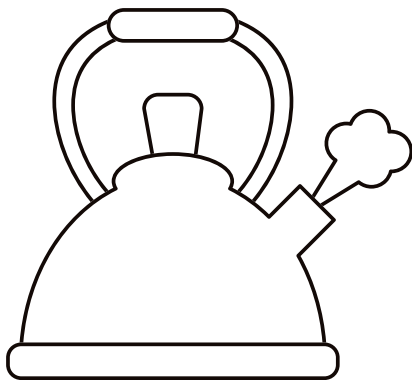
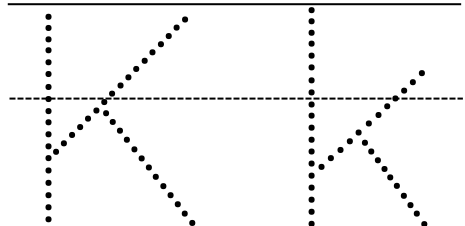
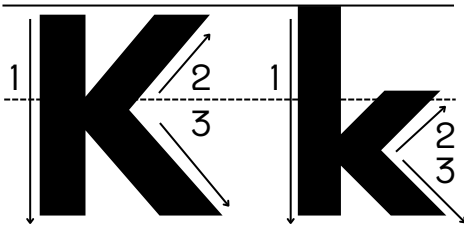
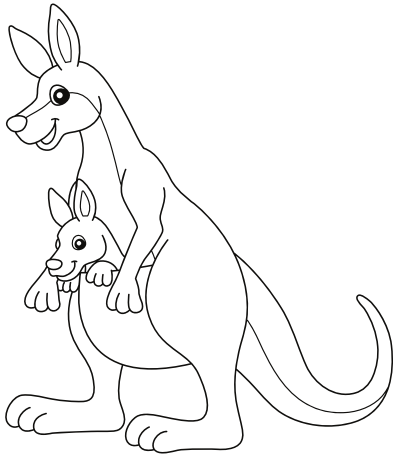
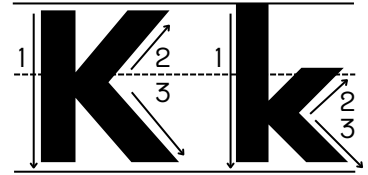

Name: \_\_\_\_\_

# Letter Sounds



Directions: Color the picture, then trace the letter.

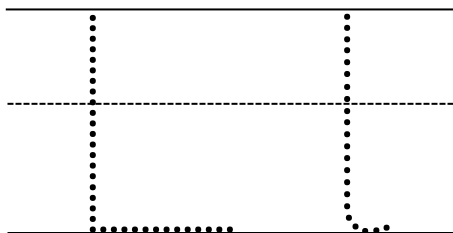
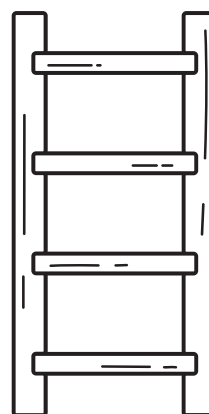
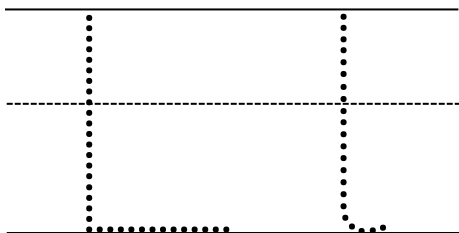
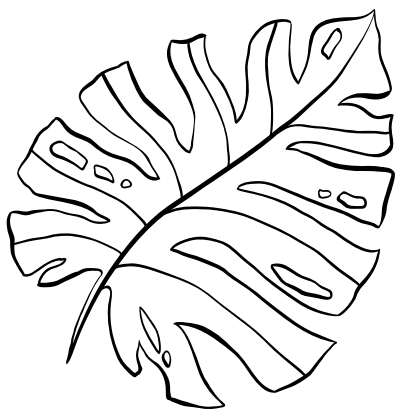
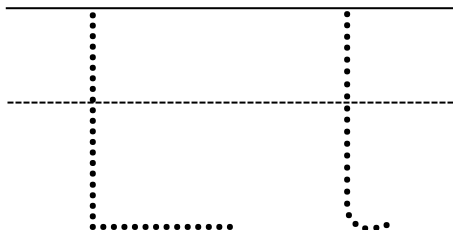
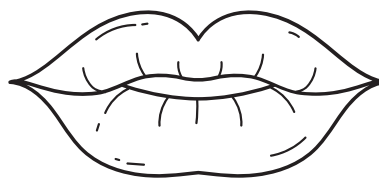
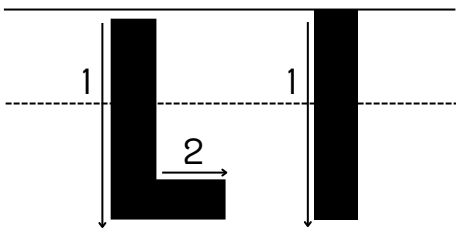
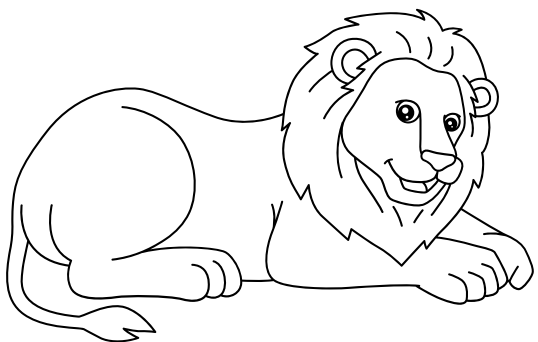
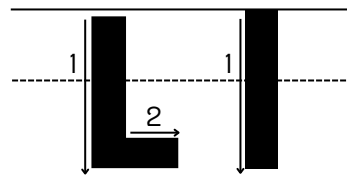

Name: \_\_\_\_\_

# Letter Sounds



Directions: Color the picture, then trace the letter.

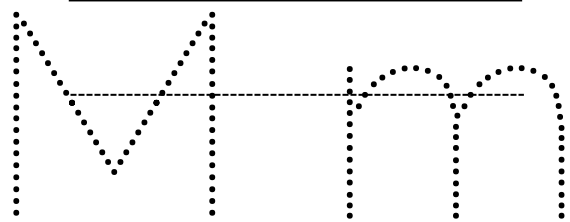
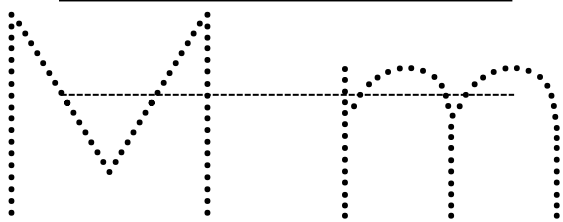
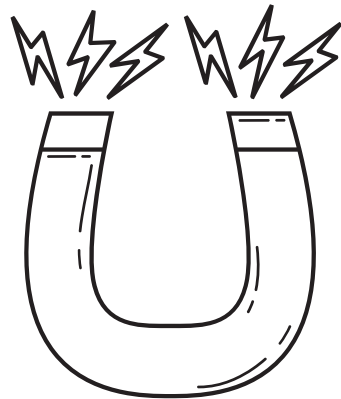
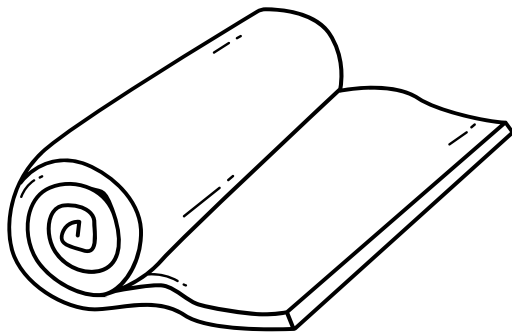
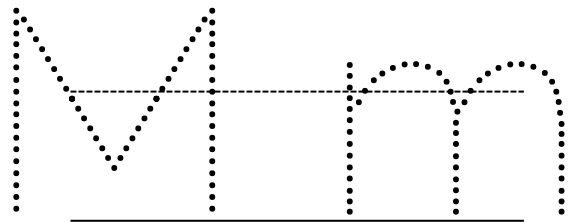
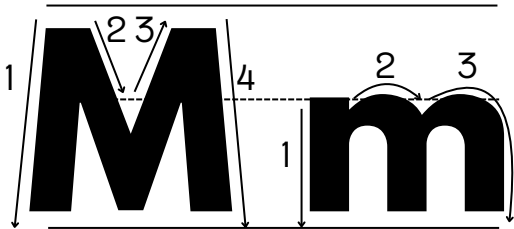
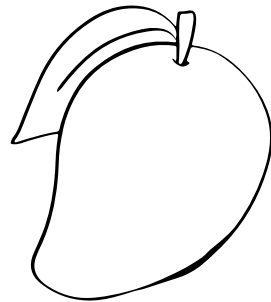
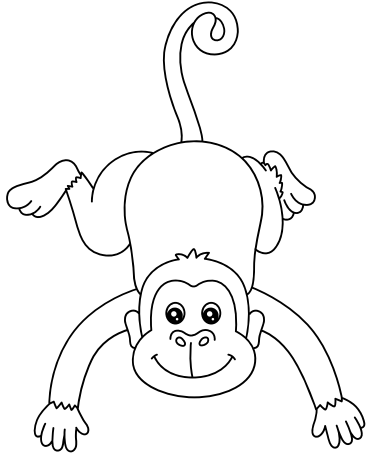
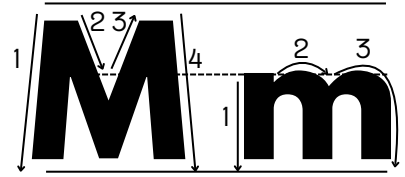

Name: \_\_\_\_\_

# Letter Sounds



Directions: Color the picture, then trace the letter.

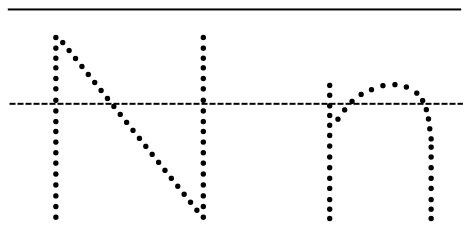
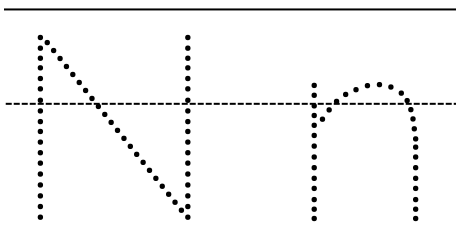
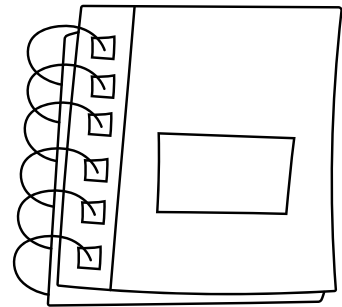
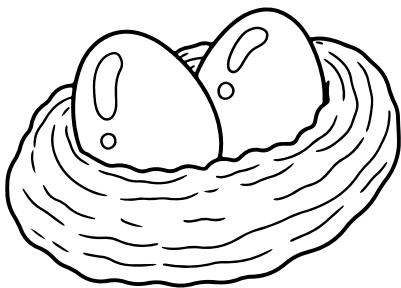
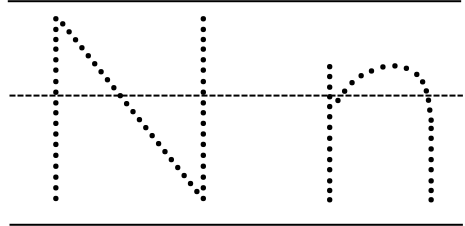
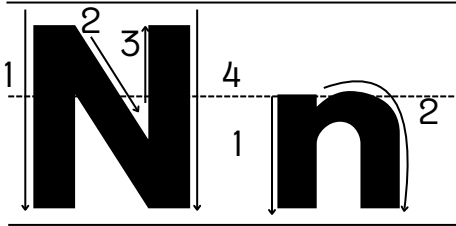
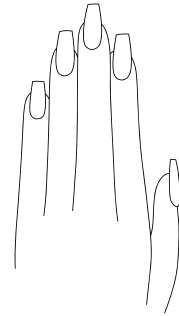
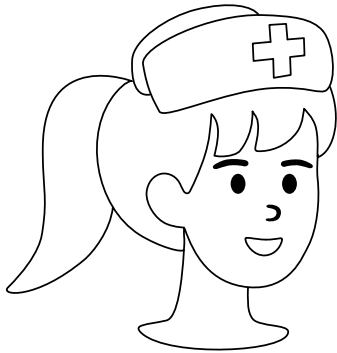
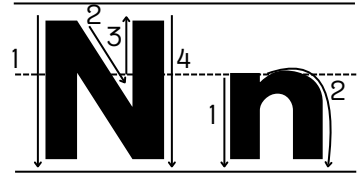

Name: \_\_\_\_\_

# Letter Sounds



Directions: Color the picture, then trace the letter.

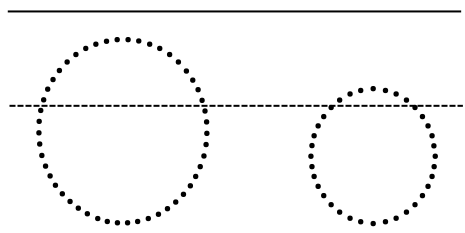
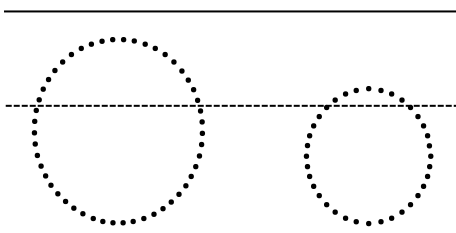
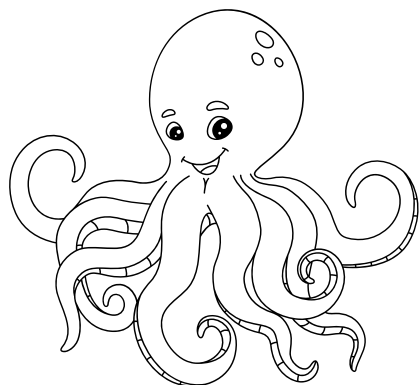
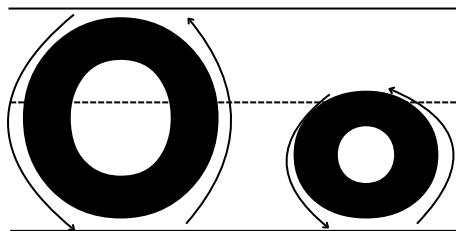
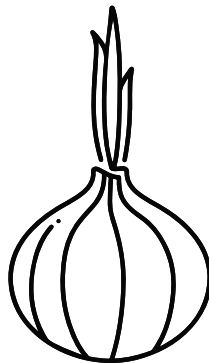
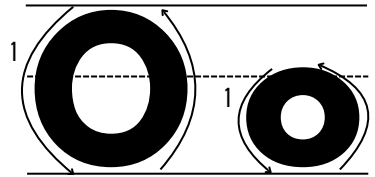



Name: \_\_\_\_\_

# Letter Sounds

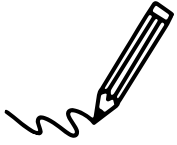

Directions: Color the picture, then trace the letter.

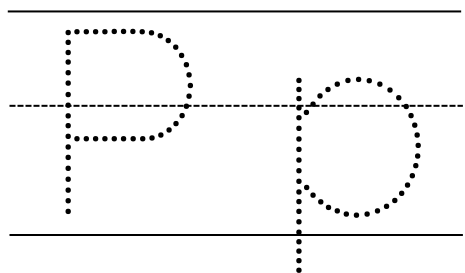
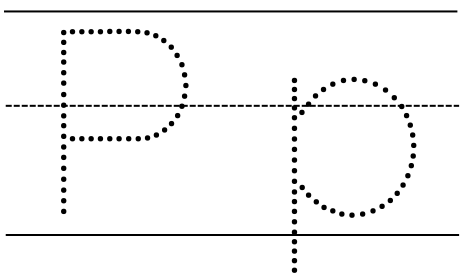
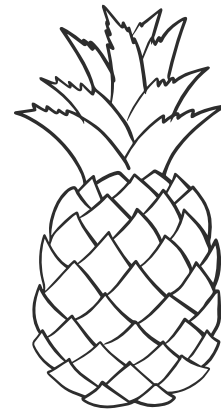
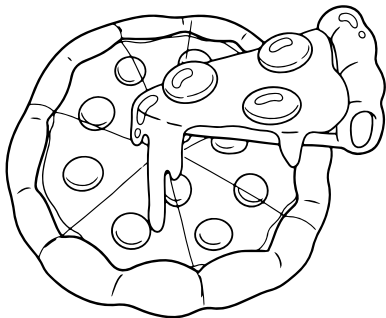
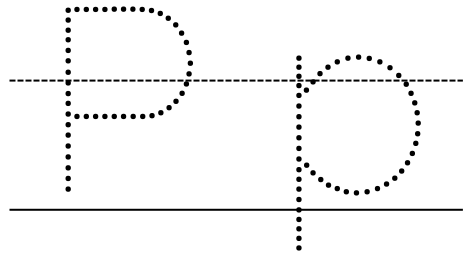
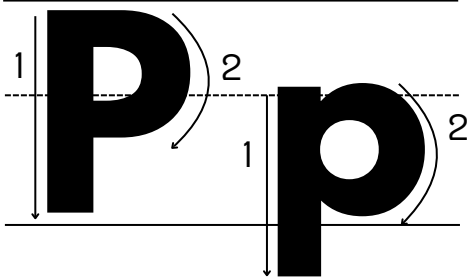
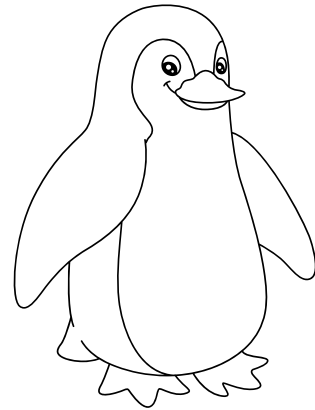
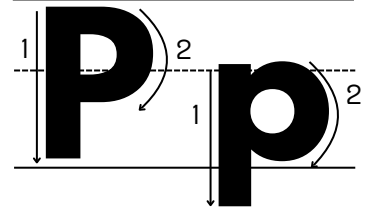

Name: \_\_\_\_\_

# Letter Sounds

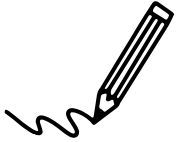

Directions: Color the picture, then trace the letter.

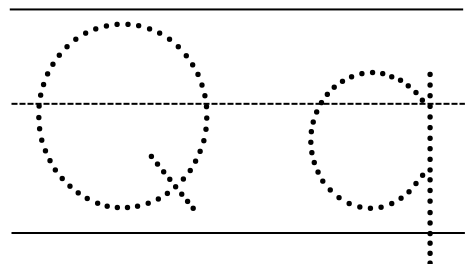
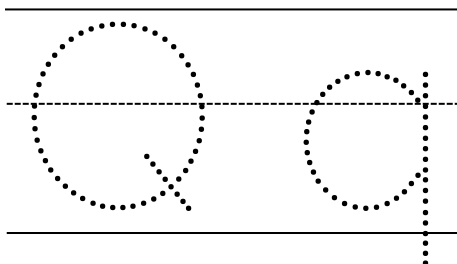
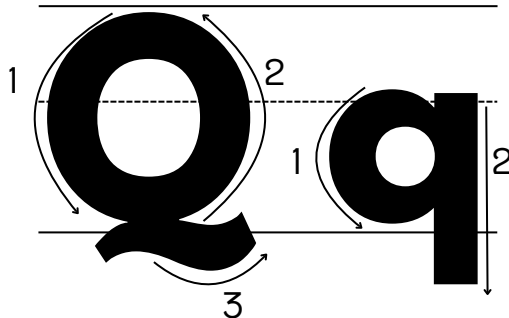
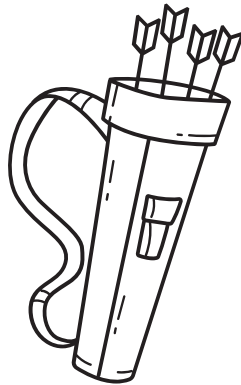
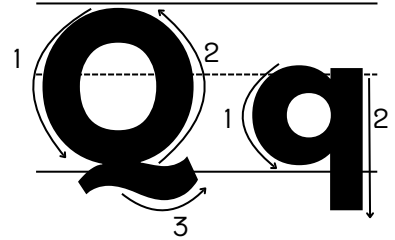

Name: \_\_\_\_\_

# Letter Sounds



Directions: Color the picture, then trace the letter.

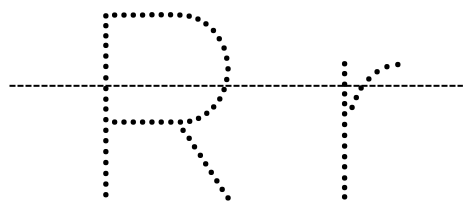
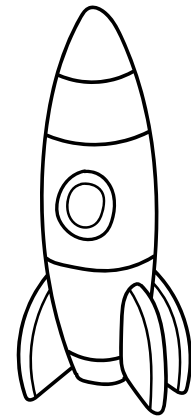
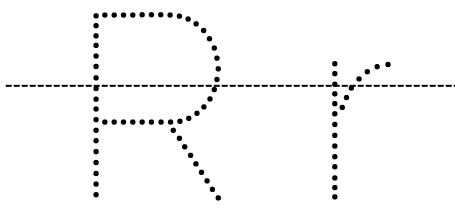
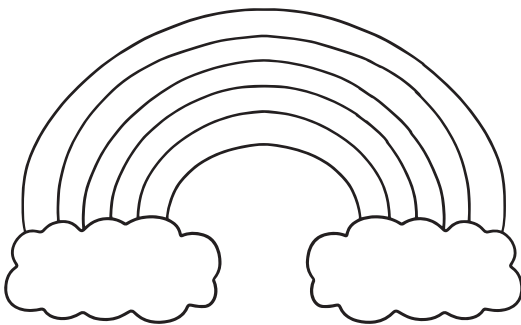
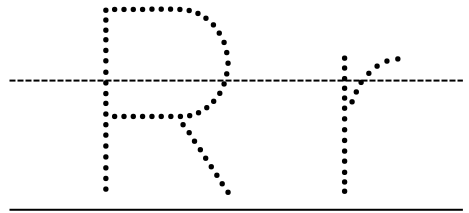
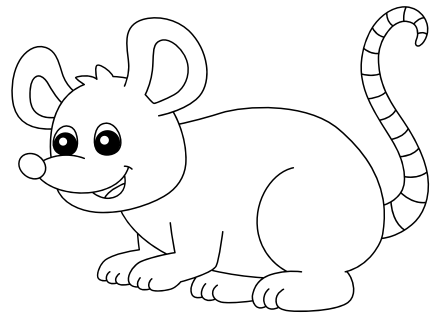
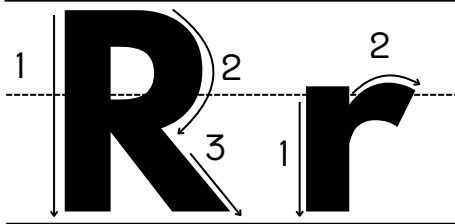
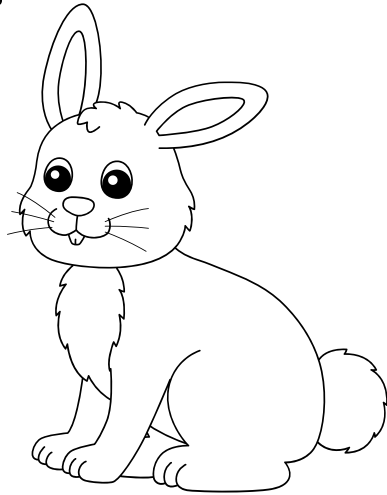
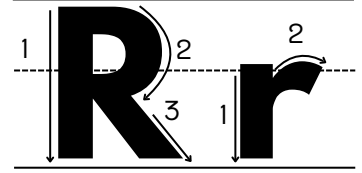

Name: \_\_\_\_\_

# Letter Sounds

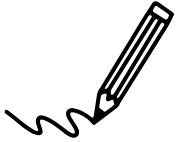

Directions: Color the picture,  
then trace the letter.

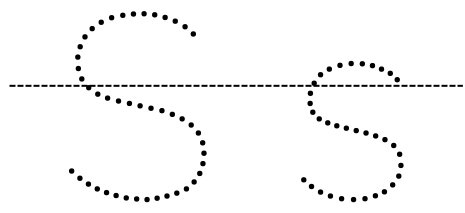
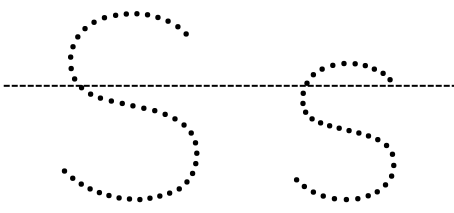
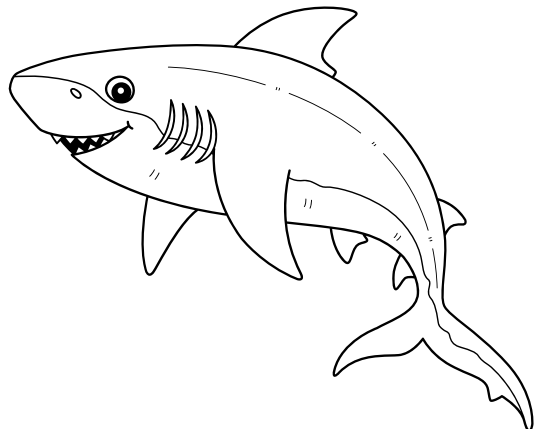
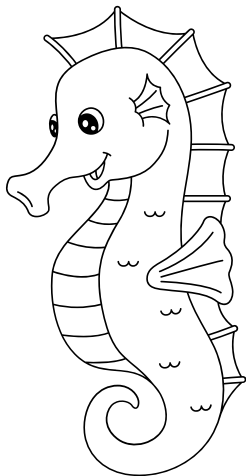
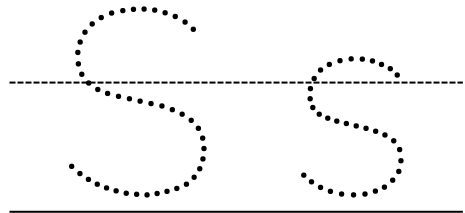
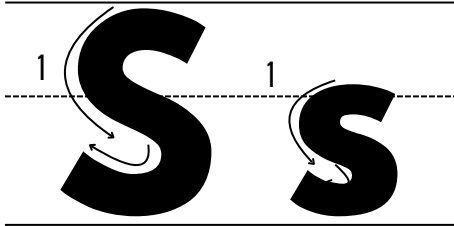
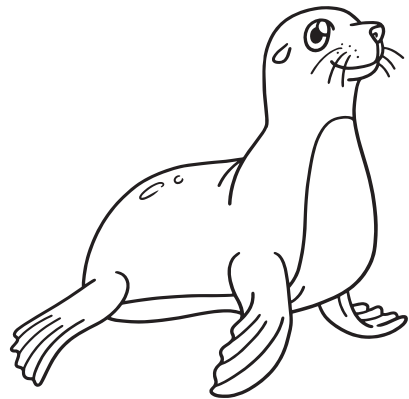
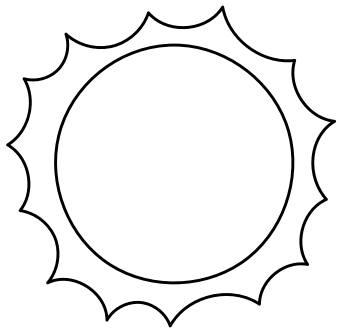
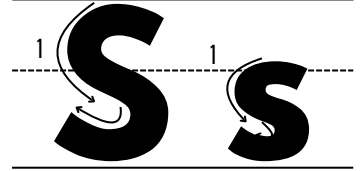

Name: \_\_\_\_\_

# Letter Sounds



Directions: Color the picture,  
then trace the letter.

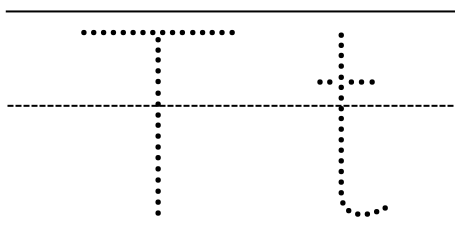
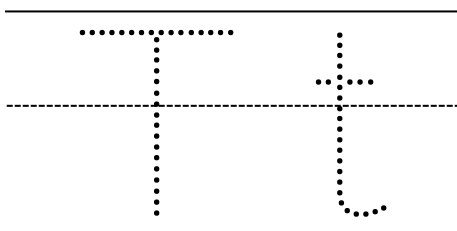
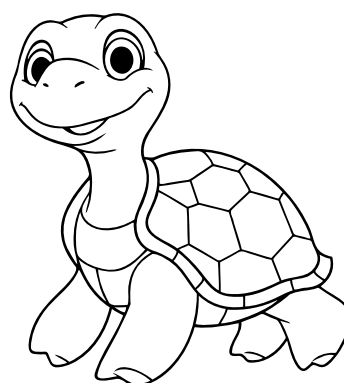
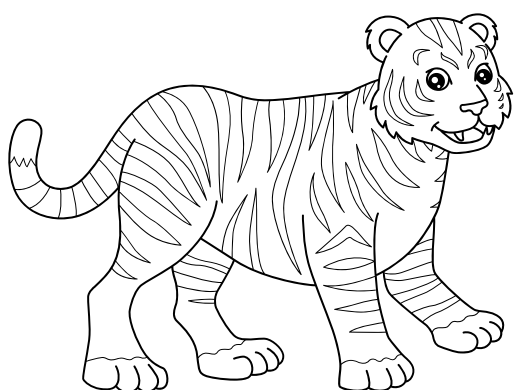
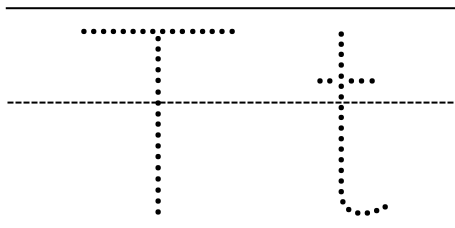
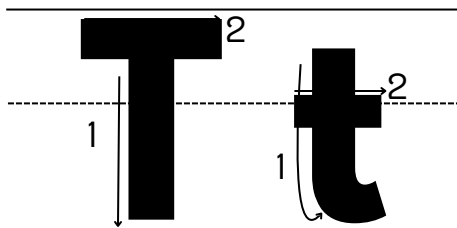
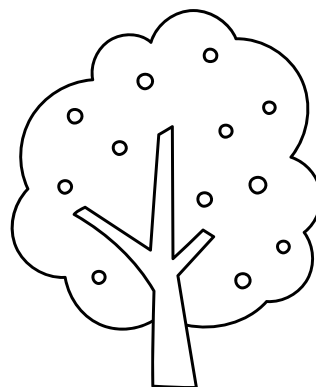
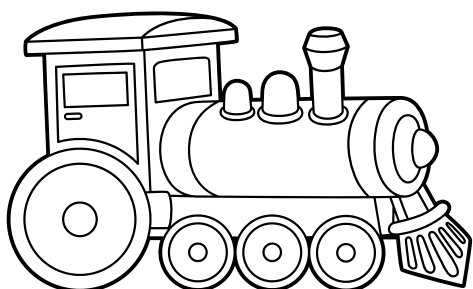
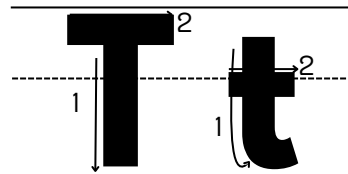

Name: \_\_\_\_\_

# Letter Sounds

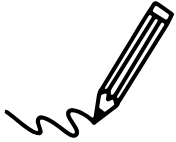

Directions: Color the picture,  
then trace the letter.

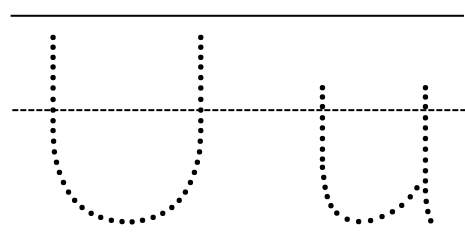
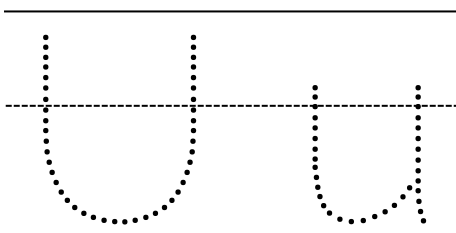
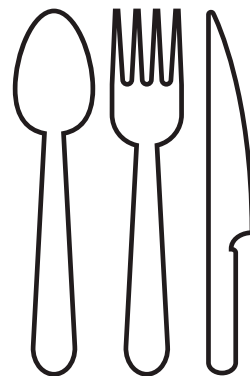
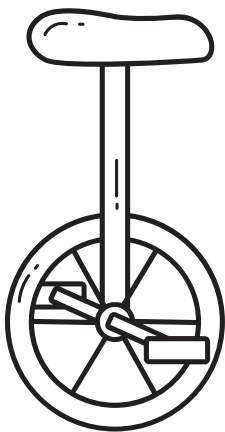
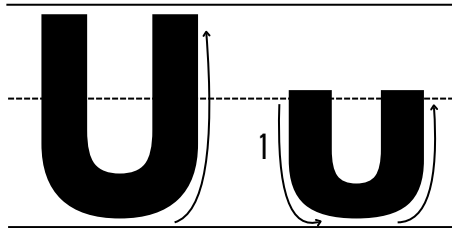
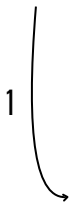
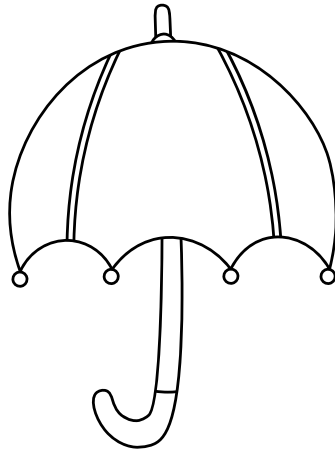
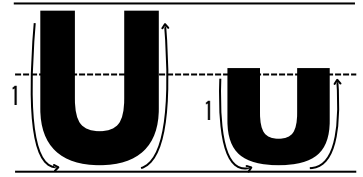

Name: \_\_\_\_\_

# Letter Sounds



Directions: Color the picture, then trace the letter.

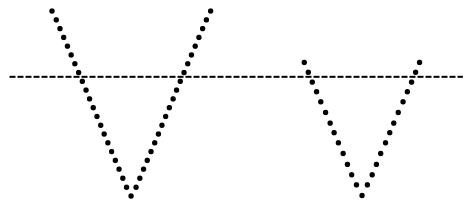
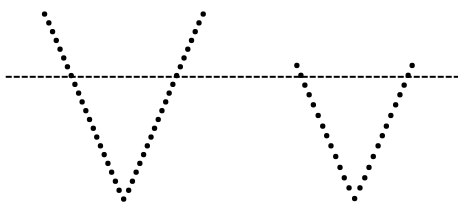
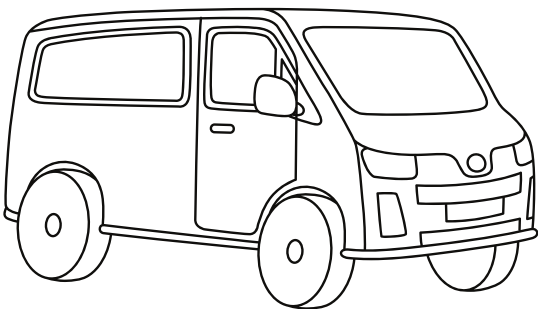
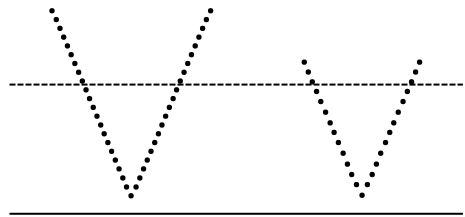
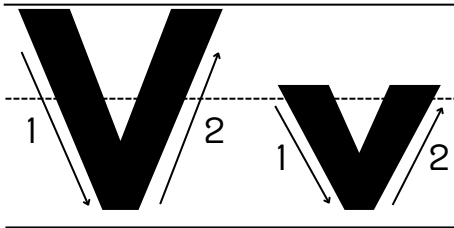
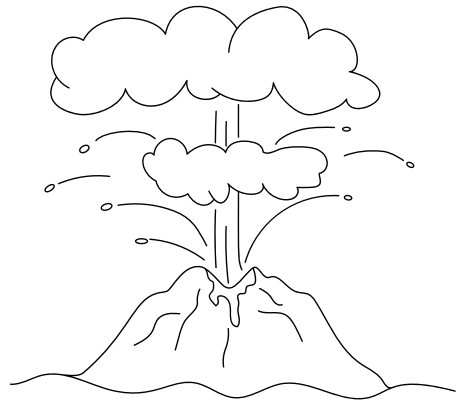
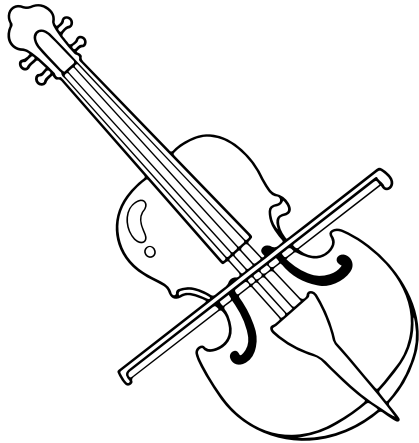
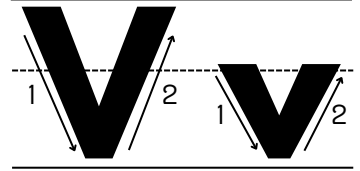

Name: \_\_\_\_\_

# Letter Sounds



Directions: Color the picture, then trace the letter.

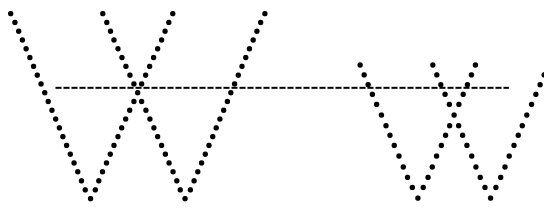
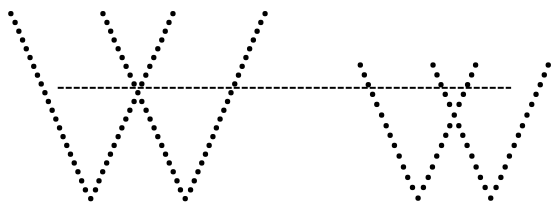
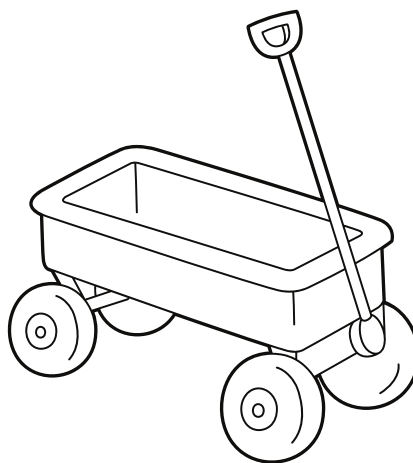
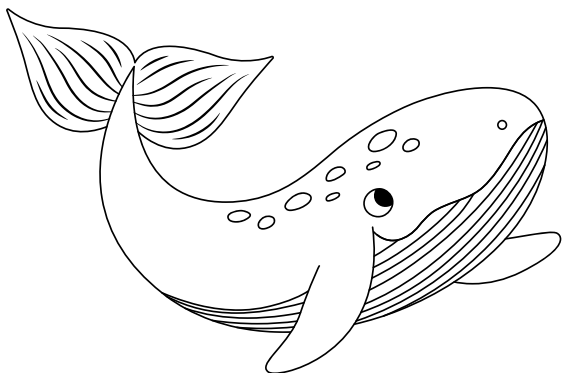
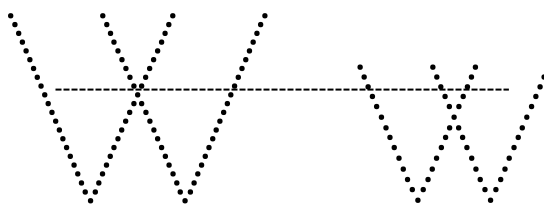
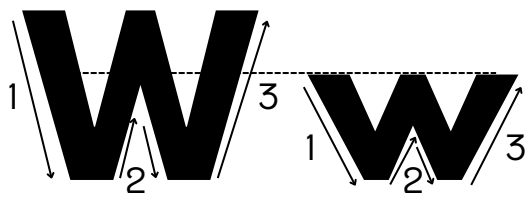
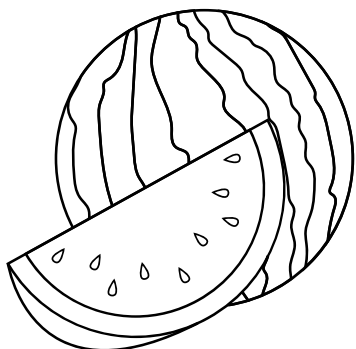
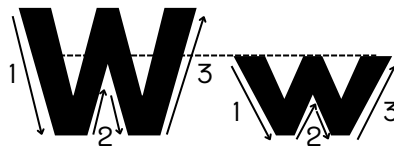



Name: \_\_\_\_\_

# Letter Sounds

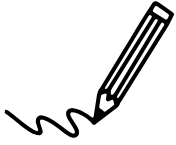

Directions: Color the picture, then trace the letter.

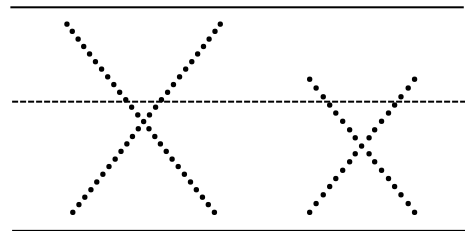
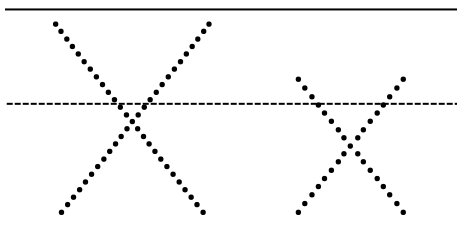
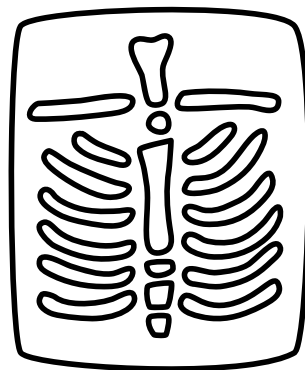
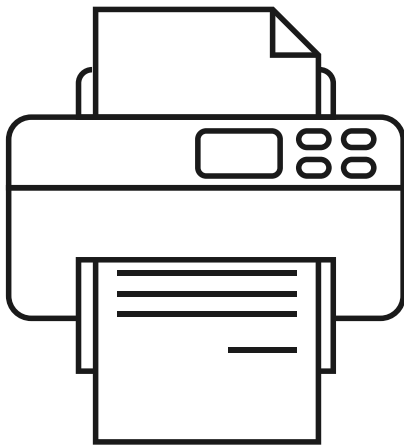
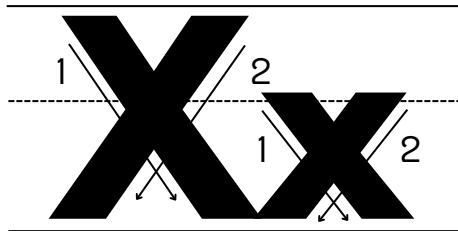
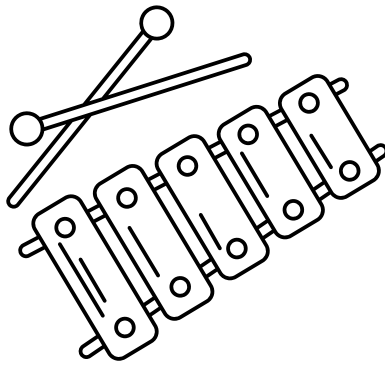
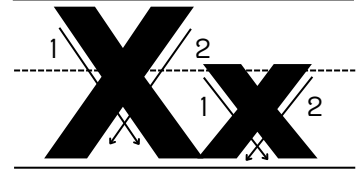

Name: \_\_\_\_\_

# Letter Sounds

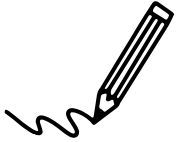

Directions: Color the picture, then trace the letter.

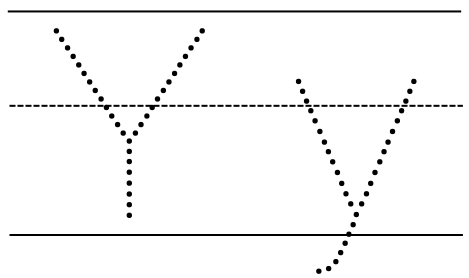
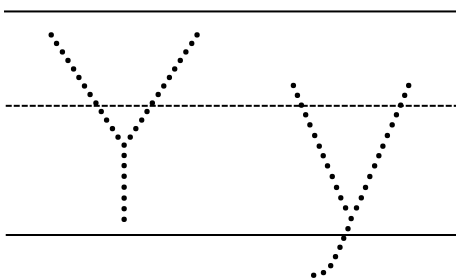
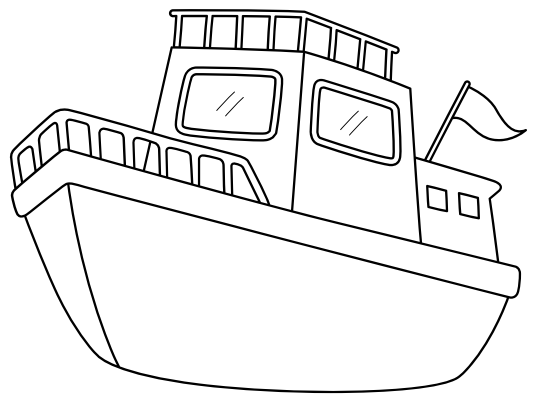
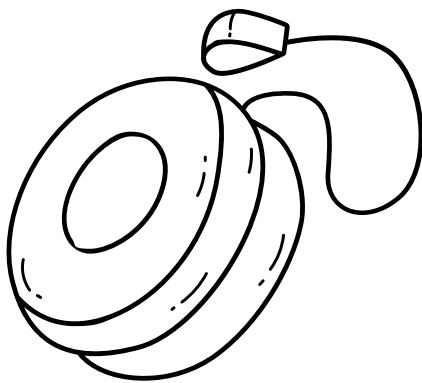
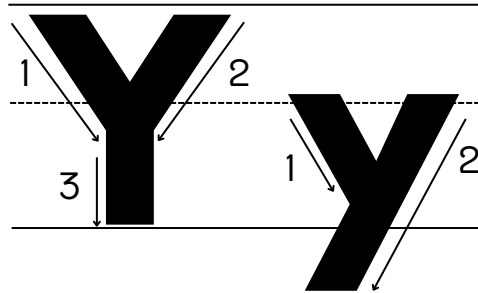
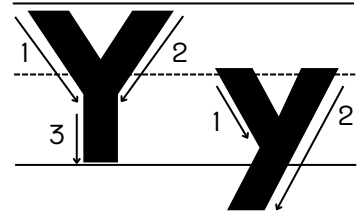

Name: \_\_\_\_\_

# Letter Sounds

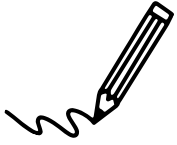

Directions: Color the picture, then trace the letter.

